



MT2303 Plastic-Encapsulate MOSFETS

P-Channel 30-V(D-S) MOSFET

FEATURE

TrenchFET Power MOSFET

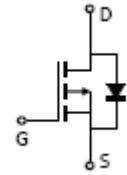

APPLICATIONS

- Load Switch for Portable Devices
- DC/DC Converter

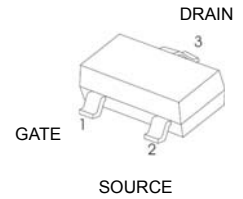

MARKING: 2303

SOT-23

Maximum ratings ($T_a=25^{\circ}\text{C}$ unless otherwise noted)

Parameter	Symbol	Value	Unit
Drain-Source Voltage	V_{DS}	-30	V
Gate-Source Voltage	V_{GS}	± 20	
Continuous Drain Current	I_D	-1.9	A
Continuous Source-Drain Diode Current	I_S	-0.83	
Maximum Power Dissipation	P_D	0.35	W
Thermal Resistance from Junction to Ambient($t \leq 5s$)	$R_{\theta JA}$	357	$^{\circ}\text{C}/\text{W}$
Junction Temperature	T_J	150	$^{\circ}\text{C}$
Storage Temperature	T_{STG}	-50 ~ +150	



Electrical characteristics (T_a=25°C unless otherwise noted)

Parameter	Symbol	Test Condition	Min	Typ	Max	Units
Static						
Drain-Source Breakdown Voltage	V _{(BR)DSS}	V _{GS} = 0V, I _D = -250μA	-30			V
Gate-Source Threshold Voltage	V _{GS(th)}	V _{DS} = V _{GS} , I _D = -250μA	-1		-3	
Gate-Source Leakage	I _{GSS}	V _{DS} = 0V, V _{GS} = ±20V			±100	nA
Zero Gate Voltage Drain Current	I _{DSS}	V _{DS} = -30V, V _{GS} = 0V			-1	μA
Drain-Source On-State Resistance ^a	R _{DS(on)}	V _{GS} = -10V, I _D = -1.9A		0.158	0.190	Ω
		V _{GS} = -4.5V, I _D = -1.4A		0.275	0.330	
Forward Transconductance ^a	g _{fs}	V _{DS} = -5V, I _D = -1.9A	1			S
Dynamic^b						
Input Capacitance	C _{iss}	V _{DS} = -15V, V _{GS} = 0V, f = 1MHz		155		pF
Output Capacitance	C _{oss}			35		
Reverse Transfer Capacitance	C _{rss}			25		
Total Gate Charge	Q _g	V _{DS} = -15V, V _{GS} = -10V, I _D = -1.9A		4	8	nC
		V _{DS} = -15V, V _{GS} = -4.5V, I _D = -1.9A		2	4	
Gate-Source Charge	Q _{gs}			0.6		
Gate-Drain Charge	Q _{gd}			1		
Gate Resistance	R _g	f = 1MHz	1.7	8.5	17	Ω
Turn-On Delay Time	t _{d(on)}	V _{DD} = -15V, R _L = 10Ω, I _D = -1.5A, V _{GEN} = -10V, R _g = 1Ω		4	8	ns
Rise Time	t _r			11	18	
Turn-Off Delay Time	t _{d(off)}			11	18	
Fall Time	t _f			8	16	
Turn-On Delay Time	t _{d(on)}	V _{DD} = -15V, R _L = 10Ω, I _D = -1.5A, V _{GEN} = -4.5V, R _g = 1Ω		36	44	
Rise Time	t _r			37	45	
Turn-Off Delay Time	t _{d(off)}			12	18	
Fall Time	t _f			9	14	
Drain-source Body diode characteristics						
Continuous Source-Drain Diode Current	I _S	T _C = 25°C			-1.75	A
Pulse Diode Forward Current ^a	I _{SM}				-10	
Body Diode Voltage	V _{SD}	I _S = -1.5A		-0.8	-1.2	V

Notes :

- a. Pulse Test : Pulse Width ≤ 300μs, Duty Cycle ≤ 2%.
- b. Guaranteed by design, not subject to production testing.



Typical Characteristics

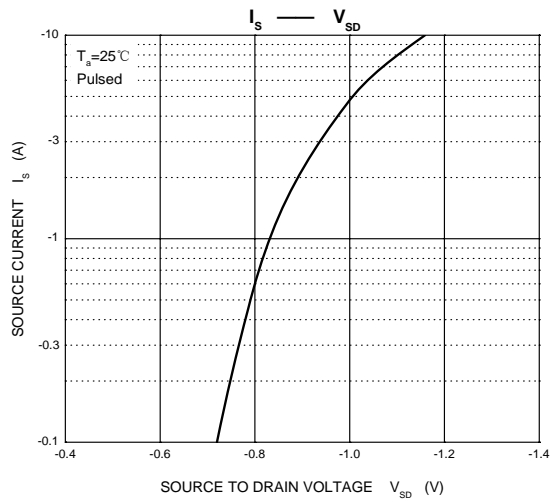
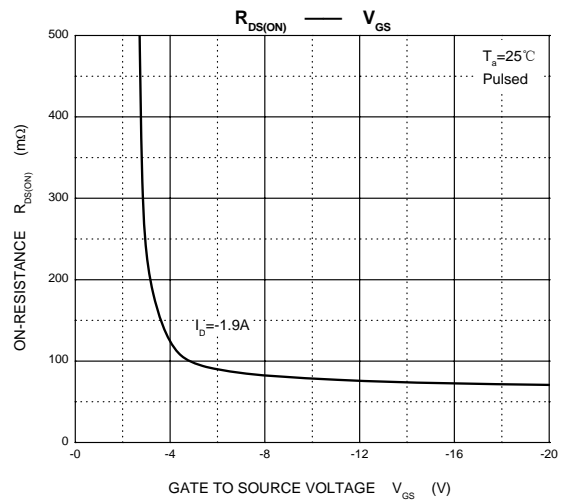
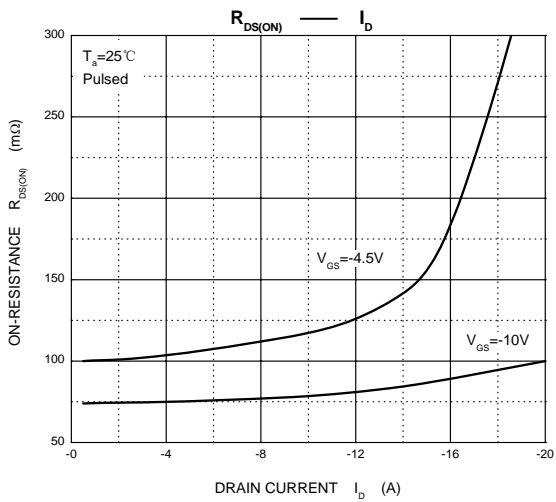
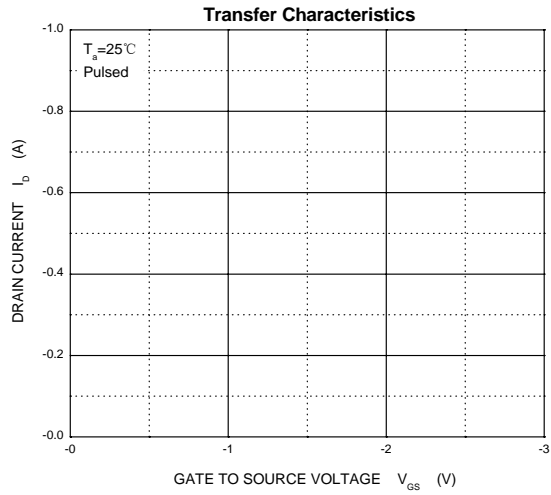
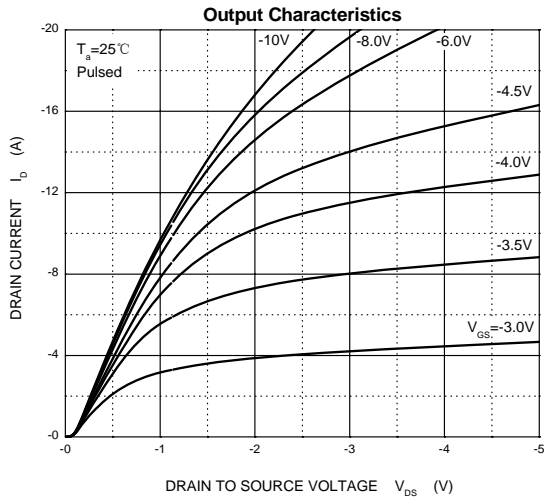



PACKAGE OUTLINE

Plastic surface mounted package; 3 leads

SOT-23

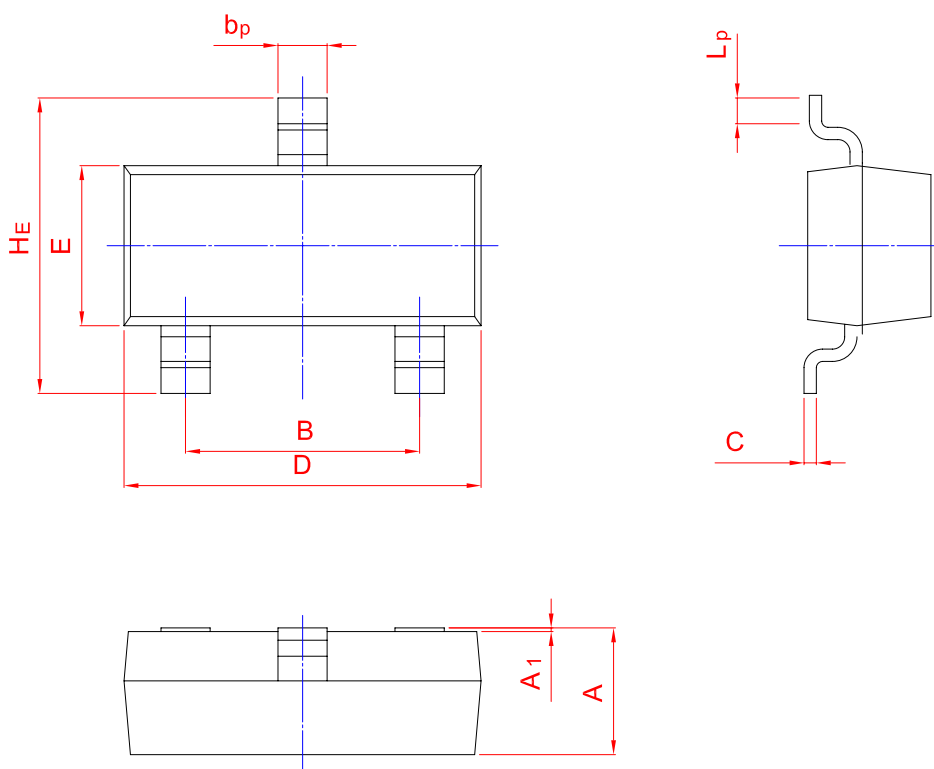
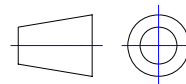

UNIT	A	B	bp	C	D	E	HE	A1	Lp
mm	1.40	2.04	0.50	0.19	3.10	1.65	3.00	0.100	0.50
	0.95	1.78	0.35	0.08	2.70	1.20	2.20	0.013	0.20